

INSTALLER: THESE INSTRUCTIONS MUST BE CONVEYED TO AND REMAIN WITH THE HOMEOWNER.

CERTIFIED UNDER CANADIAN AND AMERICAN NATIONAL STANDARDS, CSA 2.33, ANSI Z21.88 FOR VENTED GAS FIREPLACE HEATERS



QUALITY FIREPLACES
Award Winning Products

GAS-FIRED DIRECT VENT INSERT
INSTALLATION AND OPERATION INSTRUCTIONS FOR:
VENTED GAS FIREPLACE

NATURAL GAS MODELS **GDI-30N**
PROPANE GAS MODELS **GDI-30P**

WARNING: If the information in these instructions is not followed exactly, a fire or explosion may result causing property damage, personal injury or death.

FOR YOUR SAFETY

Do not store or use gasoline or other flammable vapours and liquids in the vicinity of this or any other appliance.

WHAT TO DO IF YOU SMELL GAS:

- Do not try to light any appliance.
- Do not touch any electrical switch.
- Do not use any phone in your building.
- Immediately call your gas supplier from a neighbour's phone. Follow the gas supplier's instructions.
- If you cannot reach your gas supplier, call the fire department.

Installation and service must be performed by a qualified installer, service agency or the gas supplier.



Wolf Steel Ltd., 24 Napoleon Rd., Barrie, ON L4M 4Y8 Canada • (705)721-1212 • fax(705)722-6031
www.napoleonfireplaces.com • ask@napoleon.on.ca

TABLE of CONTENTS

Pg 2-4	INTRODUCTION Warranty General Instructions General Information Care of Glass & Plated Parts	Pg 8-9	OPERATION / MAINTENANCE Operating Instructions Maintenance
5-6	INSTALLATION Insert Vent Connection Chimney Connection Gas Pipe Installation Wall Switch / Thermostat	10	BLOWER REPLACEMENT
7-8	FINISHING Log Placement Door Operation Mantle Clearances	10	ADJUSTMENTS Pilot Burner Adjustment Venturi Adjustments
		11-12	REPLACEMENTS Ordering Replacement Parts Replacement Parts Terminal Kits Accessories
		13-14	TROUBLE SHOOTING GUIDE
		15	SERVICE HISTORY

PLEASE RETAIN THIS MANUAL FOR FUTURE REFERENCE

WARNING

- The fireplace insert is a vented gas-fired heater. Do not burn wood or other materials in this fireplace insert.
- Adults and especially children should be alerted to the hazards of high surface temperatures and should stay away to avoid burns or clothing ignition. Keep young children and animals away when the fireplace insert is hot.
- Due to high temperatures, the fireplace insert should be located out of traffic and away from furniture and draperies.
- Clothing or other flammable material should not be placed on or near the fireplace insert.
- Any safety screen or guard removed for servicing must be replaced prior to operating the fireplace insert.
- It is imperative that the control compartments, burners and circulating blower and its passageway in the fireplace insert and venting system are kept clean. The fireplace insert and its venting system should be inspected before use and at least annually by a qualified service person. More frequent cleaning may be required due to excessive lint from carpeting, bedding material, etc. The fireplace insert area must be kept clear and free from combustible materials, gasoline and other flammable vapours and liquids.
- Under no circumstances should this fireplace insert be modified.
- This fireplace insert must not be connected to a chimney flue pipe serving a separate solid fuel burning appliance.
- Do not use this fireplace insert if any part has been under water. Immediately call a qualified service technician to inspect the fireplace insert and to replace any part of the control system and any gas control which has been under water.
- Do not operate the fireplace insert with the glass door opened, cracked or broken. Replacement of the glass should be done by a licensed or qualified service person.
- Do not strike or slam shut the fireplace insert glass door.
- This fireplace uses and requires a fast acting thermocouple. Replace only with a fast acting thermocouple supplied by Wolf Steel Ltd.

NAPOLEON gas fireplaces are manufactured under the strict Standard of the world recognized ISO 9001:2000 Quality Assurance Certificate.

NAPOLEON products are designed with superior components and materials, assembled by trained craftsmen who take great pride in their work. The burner and valve assembly are leak and test-fired at a quality test station. The complete fireplace is thoroughly inspected by a qualified technician before packaging to ensure that you, the customer, receives the quality product that you expect from NAPOLEON.

NAPOLEON GAS FIREPLACE PRESIDENT'S LIFETIME LIMITED WARRANTY

The following materials and workmanship in your new NAPOLEON gas fireplace are warranted against defects for as long as you own the fireplace. This covers: combustion chamber, heat exchanger, stainless steel burner, phazer™ logs and embers, ceramic glass (thermal breakage only), gold plated parts against tarnishing, porcelainized enamelled components and aluminum extrusion trims.

Electrical (110V and millivolt) components and wearable parts such as blowers, gas valves, thermal switch, switches, wiring, remote controls, ignitor, gasketing, and pilot assembly are covered and NAPOLEON will provide replacement parts free of charge during the first year of the limited warranty.

Labour related to warranty repair is covered free of charge during the first year. Repair work, however, requires the prior approval of an authorized company official. Labour costs to the account of NAPOLEON are based on a predetermined rate schedule and any repair work must be done through an authorized NAPOLEON dealer.

CONDITIONS AND LIMITATIONS

NAPOLEON warrants its products against manufacturing defects to the original purchaser only -- i.e., the individual or legal entity (registered customer) whose name appears on the warranty registration card filed with NAPOLEON -- provided that the purchase was made through an authorized NAPOLEON dealer and is subject to the following conditions and limitations:

This factory warranty is nontransferable and may not be extended whatsoever by any of our representatives.

The gas fireplace must be installed by a licenced, authorized service technician or contractor. Installation must be done in accordance with the installation instructions included with the product and all local and national building and fire codes.

This limited warranty does not cover damages caused by misuse, lack of maintenance, accident, alterations, abuse or neglect and parts installed from other manufacturers will nullify this warranty.

This limited warranty further does not cover any scratches, dents, corrosion or discolouring caused by excessive heat, abrasive and chemical cleaners nor chipping on porcelain enamel parts, mechanical breakage of PHAZER™ logs and embers, nor any venting components used in the installation of the fireplace.

NAPOLEON warrants its stainless steel burners against defects in workmanship and material for life, subject to the following conditions: During the first 10 years NAPOLEON will replace or repair the defective parts at our option free of charge. From 10 years to life, NAPOLEON will provide replacement burners at 50% of the current retail price.

In the first year only, this warranty extends to the repair or replacement of warranted parts which are defective in material or workmanship provided that the product has been operated in accordance with the operation instructions and under normal conditions.

After the first year, with respect to this President's Limited Lifetime Warranty, NAPOLEON may, at its discretion, fully discharge all obligations with respect to this warranty by refunding to the original warranted purchaser the wholesale price of any warranted but defective part(s).

After the first year, NAPOLEON will not be responsible for installation, labour or any other costs or expenses related to the reinstallation of a warranted part, and such expenses are not covered by this warranty.

Notwithstanding any provisions contained in this President's Limited Lifetime Warranty, NAPOLEON'S responsibility under this warranty is defined as above and it shall not in any event extend to any incidental, consequential or indirect damages.

This warranty defines the obligations and liability of NAPOLEON with respect to the NAPOLEON gas fireplace and any other warranties expressed or implied with respect to this product, its components or accessories are excluded.

NAPOLEON neither assumes, nor authorizes any third party to assume, on its behalf, any other liabilities with respect to the sale of this product. NAPOLEON will not be responsible for: over-firing, downdrafts, spillage caused by environmental conditions such as rooftops, buildings, nearby trees, hills, mountains, inadequate vents or ventilation, excessive venting configurations, insufficient makeup air, or negative air pressures which may or may not be caused by mechanical systems such as exhaust fans, furnaces, clothes dryers, etc.

Any damages to fireplace, combustion chamber, heat exchanger, brass trim or other component due to water, weather damage, long periods of dampness, condensation, damaging chemicals or cleaners will not be the responsibility of NAPOLEON.

The bill of sale or copy will be required together with a serial number and a model number when making any warranty claims from your authorized dealer. The warranty registration card must be returned within fourteen days to register the warranty.

NAPOLEON reserves the right to have its representative inspect any product or part thereof prior to honouring any warranty claim.

GENERAL INSTRUCTIONS

THIS GAS FIREPLACE INSERT SHOULD BE INSTALLED AND SERVICED BY A QUALIFIED INSTALLER to conform with local codes. Installation practices vary from region to region and it is important to know the specifics that apply to your area,

for example: in Massachusetts State:

- The fireplace damper must be removed or welded in the open position prior to installation of a fireplace insert or gas log.
- The appliance off valve must be a "T" handle gas cock.
- The flexible connector must not be longer than 36 inches.
- The appliance is not approved for installation in a bedroom or bathroom unless the unit is a direct vent sealed combustion product.
- A carbon monoxide detector is required in all rooms containing gas fired appliances.
- **WARNING:** This product must be installed by a licensed plumber or gas fitter when installed within the commonwealth of Massachusetts.

In absence of local codes, install to the current CAN1-B149 Installation Code in Canada or to the National Fuel Gas Code, ANSI Z223.1, and NFPA 54 in the United States. Mobile home installation must conform with local codes or in the absence of local codes, install to the current standard for gas equipped mobile housing CAN/CSA Z240 MH Series in Canada or ANSI Z223.1 and NFPA 54 in the United States.

Purge all gas lines with the glass door of the fireplace insert opened. Assure that a continuous gas flow is at the burner before closing the door.

Under extreme vent configurations, allow several minutes (5-15) for the flame to stabilize after ignition.

Objects placed in front of the fireplace must be kept a minimum of 48" away from the front face of the unit.

The fireplace insert and its individual shutoff valve must be disconnected from the gas supply piping system during any pressure testing of that system at test pressures in excess of 1/2 psig (3.5 kPa). The fireplace insert must be isolated from the gas supply piping system by closing its individual manual shutoff valve during any pressure testing of the gas supply piping system at test pressures equal to or less than 1/2 psig (3.5 kPa).

A 1/8 inch NPT plug, accessible for test gauge connection, must be installed immediately upstream of the gas supply connection to the fireplace insert.

The fireplace insert must be electrically connected and grounded in accordance with local codes. In the absence of local codes, use the current CSA C22.1 CANADIAN ELECTRICAL CODE in Canada or the ANSI/NFPA 70 NATIONAL ELECTRICAL CODE in the United States. The blower power cord must be connected into a properly grounded recepta-

GENERAL INFORMATION

cle. The grounding prong must not be removed from the cord plug.

FOR YOUR SATISFACTION, THIS FIREPLACE INSERT HAS BEEN TEST-FIRED TO ASSURE ITS OPERATION AND QUALITY!

Minimum inlet gas supply pressure is 4.5 inches water column for natural gas and 11 inches water column for propane. Maximum inlet gas pressure is 7 inches water column for natural gas and 13 inches water column for propane. Manifold pressure under flow conditions is 3.5 inches water column for natural gas and 10 inches water column for propane. When the fireplace is installed at elevations above 4,500ft, and in the absence of specific recommendations from the local authority having jurisdiction, the certified high altitude input rating shall be reduced at the rate of 4% for each additional 1,000ft.

Expansion / contraction noises during heating up and cooling down cycles are normal and to be expected.

Maximum input is 24,500 BTU/hr for natural gas and propane. Maximum output for natural gas and propane is 20,825 BTU/hr at an efficiency of 85% with the fan on. The maximum A.F.U.E. (annual fuel utilization efficiency) rating is 82%. This fireplace insert is not approved for closet or recessed installations. It is approved for bathroom, bedroom and bed-sitting room installations and is suitable for mobile homes. The natural gas model is suitable for installation in a mobile home that is permanently positioned on its site and fuelled with natural gas.

This insert must be recessed into a vented noncombustible wood-burning fireplace (prefabricated or masonry) only. The minimum fireplace opening size in which the heater is to be installed is:

HEIGHT 21.75" WIDTH 28" DEPTH 18"

The minimum allowable chimney flue size is 6" round.

The minimum distance, from the bottom of a combustible mantle projecting 3" maximum from the wall to the top of the louvre opening, is 12". A non-combustible hearth must

CARE OF GLASS, AND PLATED PARTS

protrude a minimum of 18" from the unit unless the insert is elevated a minimum of 12" above the combustible flooring. Do not use abrasive cleaners to clean these parts. Buff lightly with a clean dry cloth.

The glass is 3/16" ceramic glass available from your Napoleon / Wolf Steel Ltd. dealer. **DO NOT SUBSTITUTE MATERIALS.** Clean the glass after the first 10 hours of operation with a recommended gas fireplace glass cleaner. Thereafter clean as required. **DO NOT CLEAN GLASS**

INSTALLATION

WHEN HOT! If the glass is not kept clean permanent discoloration and / or blemishes may result.

Provide adequate ventilation air.

Provide adequate accessibility clearance for servicing and operating the fireplace insert.

Never obstruct the front opening of the fireplace insert.

Objects placed in front of the fireplace must be kept a minimum of 48" away from the front face of the unit.

FIGURE 1 a-c

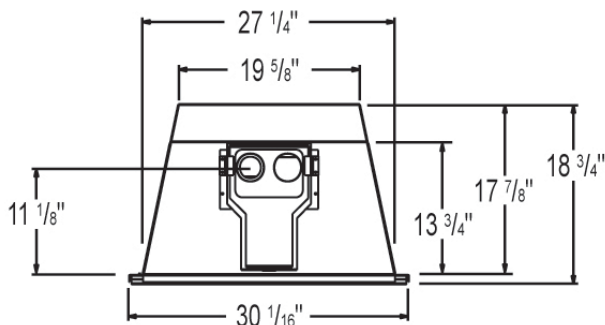
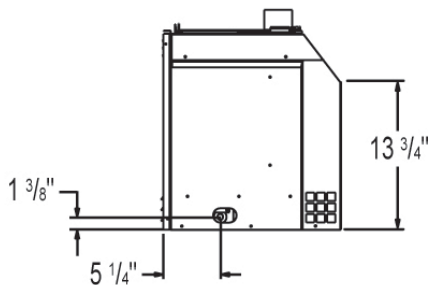
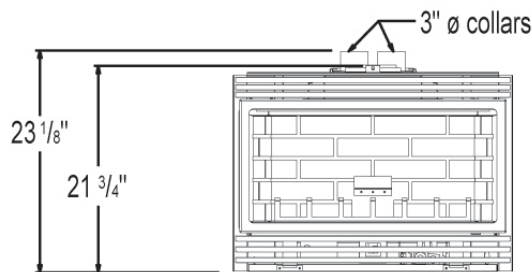

Clean out ashes from the inside of the wood-burning fireplace. Make sure that the chimney and wood-burning fireplace are in a clean and sound condition and constructed of non-combustible materials. If necessary have any repair work done by a qualified person before installing the insert. Remove the existing fireplace damper or lock into an open position.

Using screws, attach the fireplace warning tag (W385-0199) to the inside of the firebox of the fireplace into which the insert is being installed.

WARNING: THIS FIREPLACE HAS BEEN CONVERTED FOR USE WITH A GAS FIREPLACE INSERT ONLY AND CANNOT BE USED FOR BURNING WOOD OR SOLID FUELS UNLESS ALL ORIGINAL PARTS HAVE BEEN REPLACED AND THE FIREPLACE IS RE-APPROVED BY THE AUTHORITY HAVING JURISDICTION.

ATTENTION: CE FOYER A ETE CONVERTI AFIN D'ETRE UTILISE SEULEMENT COMME FOYER ENCASTRE AU GAZ ET NE PEUT ETRE UTILISE POUR BRULER DU BOIS OU TOUT AUTRE COMBUSTIBLE SOLIDE, SANS QUE TOUTES LES PIECES ORIGINALES AIENT ETE REMPLACEES ET QUE LE FOYER SOIT APPROUVE DE NOUVEAU PAR LES AUTORITES AYANT JURISDICTION.

W385-0199

The sheet-metal parts of the fireplace, in which the gas fireplace insert is to be installed, must not be cut.

If the wood-burning factory-built fireplace has no gas access hole(s) provided, an access hole of 1 1/2 inch or less may be drilled through the lower sides or bottom of the fireplace in a proper workman like manner. This access hole must be plugged with non-combustible insulation after the gas supply line has been installed.

Ensure that existing chimney cleanouts fit properly.

The refractory, glass doors, screen rails, screen mesh and log grates may be removed from the fireplace before installing the gas fireplace insert.

Smoke shelves, shields and baffles may be removed if attached by mechanical fasteners.

The ventilation openings in the fireplace may be obstructed by the backer plates, aluminium trim etc. but these parts are not to be applied so as to have an airtight seal.

INSERT VENT CONNECTION

Move the insert close to its final position inside the wood-burning fireplace. This unit is equipped with 4 levelling screws located in the four inside corners beneath the log support. Level using the levelling screws to eliminate rocking or excessive noise when the fan is in operation. Once the unit is level, move it partially into place within the fireplace to allow for all connections to be made. *It is not practical to level the insert once it has been installed. Determine the required depth prior to installing the unit and adjust the four levelling screws accordingly.*

CHIMNEY CONNECTION

Chimney installation must conform to both national and local code requirements. The chimney must be lined with one 2" or 3" diameter liner for intake and one 3" diameter liner for exhaust. The minimum and maximum vent lengths are 10 and 35 feet respectively. Recommended Napoleon kits come in 3 lengths:

1-2" & 1-3" DOUBLE PLY ALUMINUM LINER-INLET AND EXHAUST & 2-3" TO 2" REDUCER:

GDI-2320KT	VENT KIT 20FT
GDI-2325KT	VENT KIT 25FT
GDI-2335KT	VENT KIT 35FT

2-3" DOUBLE PLY ALUMINUM LINER-INLET AND EXHAUST:

GDI-320KT	VENT KIT 20FT
GDI-325KT	VENT KIT 25 FT
GDI-335KT	VENT KIT 35 FT

While the liners must be continuous from the fireplace to the chimney cap, to achieve the needed length, they may be coupled, using an approved coupler.

We recommend that exhaust vents that pass through unheated spaces, such as a garage or attic, be wrapped in a protective sleeve to minimize condensation and reverse flow symptoms. See Trouble Shooting for details.

This unit is approved for use with a 2" liner for air intake and a 3" liner for exhaust. For best performance, however, it is recommended to use two 3" liners.

If a 2" liner is used for the intake, it may be necessary to adjust the primary air shutter.

1. **OUTSIDE:** Slip the one end of a liner a minimum of 2" over the sleeve of the air terminal. Secure using 3 screws. Then seal the joint and screw heads with high temperature sealant. Repeat with the other liner.

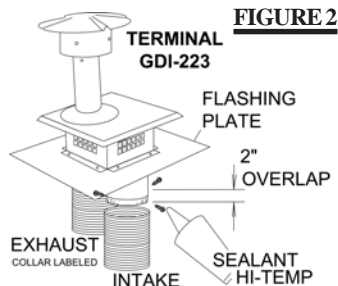

NOTE: We recommend that the other end of the exhaust liner be marked to eliminate the exhaust liner being connected to the intake collar at the unit.

2. Gently stretch the liners to the required lengths and insert into the chimney. Trim and fit the flashing plate to suit the chimney termination. Place the air terminal onto the top of the chimney. Make weather tight by sealing with caulking (not supplied). Fasten to the chimney with screws and plugs (not supplied).

3. **INSIDE:** Remove the securing screw from the front of the vent mounting plate. Pull the vent mounting plate *only*, back into the track, to the front stop. Start the slider back into position. Re-secure the screw. The insert may now be pushed into its final position inside the woodburning fireplace, and the screw tightened until the slider has been pulled tight to the front stop.

4. Route the flex liners through the slider. Attach and secure the liners to the vent mounting plate using the same procedure as before, **ensuring that the marked exhaust liner is attached to the exhaust collar.**

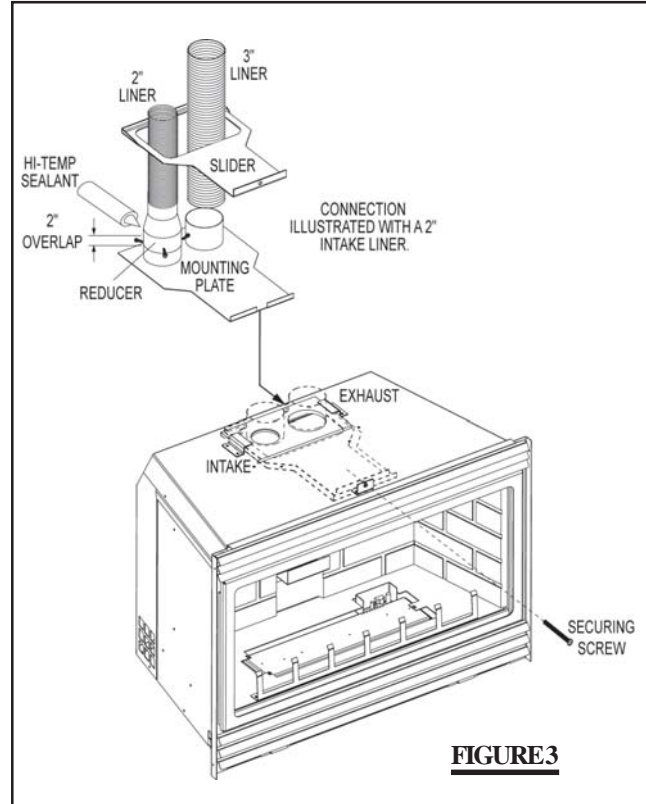

GAS INSTALLATION

Install suitable supply piping connection to a flex connector (as per local gas codes).

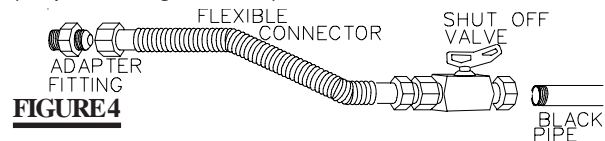

WALL SWITCH / THERMOSTAT

For ease of accessibility, an optional remote wall switch or millivolt thermostat may be installed in a convenient location. Route 2-strand solid core millivolt wire from the gas fireplace insert to the wall switch / millivolt thermostat. The recommended maximum lead length depends on the wire size:

WIRE SIZE	MAX. LENGTH
14gauge	100 feet
16gauge	60 feet
18gauge	40 feet

Do not connect either the wall switch, thermostat or gas valve to electricity (110 VOLTS).

FINISHING

LOG PLACEMENT

PHAZER™ logs and glowing embers exclusive to Napoleon Fireplaces, provide a unique and realistic glowing effect that is different in every installation. Take the time to carefully position the glowing embers for a maximum glowing effect. Log colours may vary. During the initial use of the fireplace, the colours will become more uniform as colour pigments burn in during the heat activated curing process.

FIGURE 5a-d



1. Place the back log (#1) onto the log support tray and behind the tabs. The tabs maintain an air space between the log and the burner to facilitate combustion air flow. Ensure that the back of the log rests against the bracket on the back wall of the firebox.

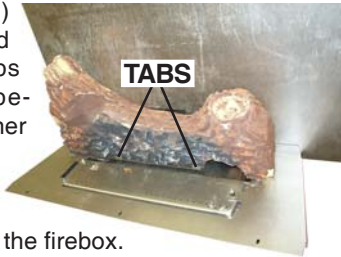

2. Move the two small logs (#2 & #3) into position, lining up the studs located on the burner with the holes on the bottom of the logs. Ensure that the small logs sit flat on the burner.



3. Place the bottom of the left crossover log (#4) against the left firebox side and pulled forward to the grate. The top of the log should rest in the pocket on the back log.



4. Position the notch located on the end of the center log (#5) against the middle grate post with the other end of the log resting in the pocket of the left crossover log.



5. Place the bottom of the right crossover log (#6) against the right firebox side and pulled forward to the grate. The top of the log should rest in the pocket provided on the center log (#5).

OPTIONAL CHARCOAL EMBERS

Randomly place the charcoal embers along the front and sides of the log support tray in a realistic manner. *Fine dust found in the bottom of the bag should not be used.*

GLOWING EMBERS

Tear the embers into pieces and place along the front row of ports covering all of the burner area in front of the small logs (#2 & #3). Care should be taken to shred the embers into thin, small irregular pieces as only the exposed edges of the fibre hairs will glow. *The ember material will only glow when exposed to direct flame; however, care should be taken to not block the burner ports.*

Blocked burner ports can cause an incorrect flame pattern, carbon deposits and delayed ignition. **PHAZER™** logs glow when exposed to direct flame. Use only certified "glowing embers" and **PHAZER™** logs available from your Napoleon dealer.

DOOR OPERATION

The upper louvres must be removed to allow the door to be opened or closed. Release the top and bottom door latches, located at the right side of the door.

FIGURE 6

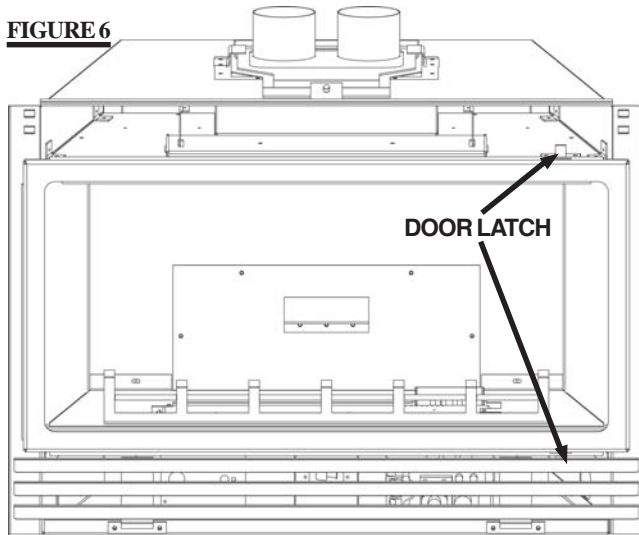

MANTLE CLEARANCE

This can vary according to the mantle depth. Use the graph to help evaluate the clearance needed.

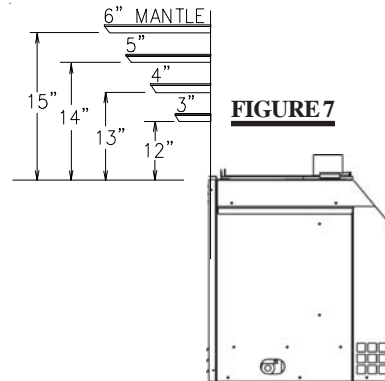
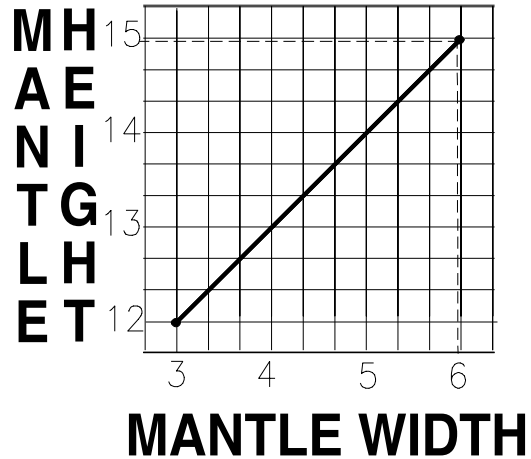

FIGURE 7



OPERATION / MAINTENANCE

OPERATING INSTRUCTIONS

Purge all gas lines with the glass door open. Assure that a continuous gas flow is at the burner before closing the door. Allow several minutes (5-15) for the flame to stabilize after ignition.

Do not operate the main burner of the insert with the door opened.

When lit for the first time, the fireplace will emit a slight odour for a few hours. This is a normal temporary condition caused by the "burn-in" of paints and lubricants used in the manufacturing process and will not occur again. Simply open a window to sufficiently ventilate the room. After extended periods of non-operation such as following a vacation or a warm weather season, the fireplace may emit a slight odour for a few hours. This is caused by dust particles in the heat exchanger burning off. Open a window to sufficiently ventilate the room.

PURGE THE GAS LINE WITH THE GLASS DOOR OPEN.

FOR YOUR SAFETY READ BEFORE LIGHTING:

- A.** This fireplace is equipped with a pilot which must be lit by hand. While following these instructions exactly.
- B.** Before operating smell all around the fireplace area for gas and next to the floor because some gas is heavier than air and will settle on the floor.
- C.** Use only your hand to turn the gas control knob. Never use tools. If the knob will not turn by hand, do not try to repair it. Call a qualified service technician. Force or attempted repair may result in a fire or explosion.
- D.** Do not use this fireplace if any part has been under water. Immediately call a qualified service technician to inspect the fireplace and replace any part of the control system and any gas control which has been under water.

WHAT TO DO IF YOU SMELL GAS:

- Turn off all gas to the fireplace.
- Open windows.
- Do not try to light any appliance.
- Do not touch any electric switch; do not use any phone in your building.
- Immediately call your gas supplier from a neighbour's phone. Follow the gas supplier's instructions.
- If you cannot reach your gas supplier, call the fire department.

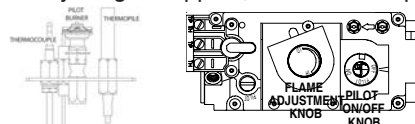
**LIGHTING INSTRUCTIONS**

When lighting and re-lighting, the gas knob cannot be turned from pilot to off unless the knob is **depressed slightly**.

1. **Stop!** Read the above safety information on this label.
2. **Turn** off all electric power to the fireplace.
3. **Turn** the gas knob clockwise to off.
4. **Wait** five (5) minutes to clear out any gas. If you smell gas including near the floor. Stop! Follow "B" in the above safety information on this label. If you don't smell gas go the next step.
5. Find pilot located in front of back log.
6. **Turn** gas knob counter-clockwise to pilot.

7. **Depress** slightly and hold gas knob while lighting the pilot with the push button ignitor. Keep knob depressed for one minute, then release. If pilot does not continue to burn, repeat steps 3 through 7.

8. **With** pilot lit, depress and turn gas knob counter-clockwise to on.

9. **If** equipped with flame adjustment valve, push and turn knob to high.

10. **If** equipped with remote on-off switch/thermostat, main burner may not come on when you turn valve to on. Remote switch must be in the on position to ignite burner.

11. **Turn** on all electric power to the fireplace.

TO TURN OFF GAS

1. Turn off all electrical power to the unit if service is to be performed.
2. Push in gas control knob slightly and turn clockwise to off. **Do not force.**

MAINTENANCE

TURN OFF THE GAS AND UNPLUG ELECTRICAL POWER BEFORE SERVICING THE FIREPLACE INSERT!

CAUTION: Label all wires prior to disconnection when servicing controls. Wiring errors can cause improper and dangerous operation. Verify proper operation after servicing. This insert and its venting system should be inspected before use and at least annually by a qualified service person. The fireplace area must be kept clear and free of combustible materials, gasoline or other flammable vapours and liquids. The flow of combustion and ventilation air must not be obstructed.

1. In order to properly clean the burner and pilot assembly, remove the logs exposing both assemblies.

2. Keep the control compartment, logs, burner, air shutter opening and the area surrounding the logs clean by vacuuming or brushing, at least once a year.

3. Check to see that all burner ports are burning. Clean out any of the ports which may not be burning or are not burning properly.

4. Check to see that the pilot flame is large enough to engulf the thermocouple on one leg and reaches toward the burner on the other leg.

5. Replace the cleaned logs.

6. Check to see that the main burner ignites completely on all openings when the gas knob for the burner is turned on. A 5-10 second total light-up period is satisfactory. If ignition takes longer, consult your Napoleon dealer/distributor.

7. Check that the door gasketing is not broken or missing. Replace if necessary.

Remove the pilot screw cap. Adjust the pilot screw to provide properly sized flame. Turn in a clockwise direction to reduce the gas flow. Replace the pilot screw cap.

Natural gas has the air shutter set at 1/4" opening; propane has the air shutter set at 3/8" opening. Closing the air

BLOWER REPLACEMENT INSTALLATION

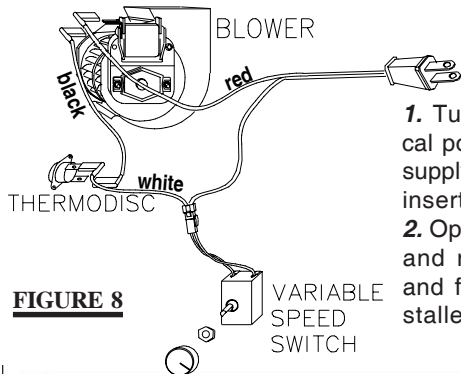

FIGURE 8

1. Turn off the electrical power and the gas supply to the fireplace insert.
2. Open the glass door and remove the logs and fibre bricks, if installed.

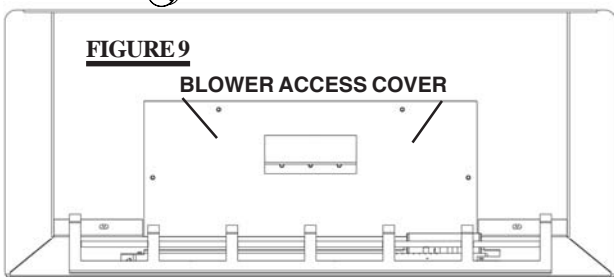

FIGURE 9

3. Remove the blower access cover held on with 4 screws.

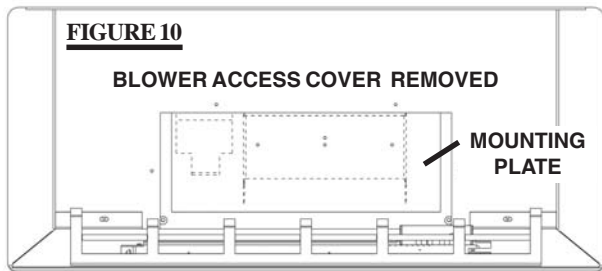

FIGURE 10

4. Remove the blower mounting plate with the blower attached.
- NOTE:** Check the blower gasket for damage. Replace if

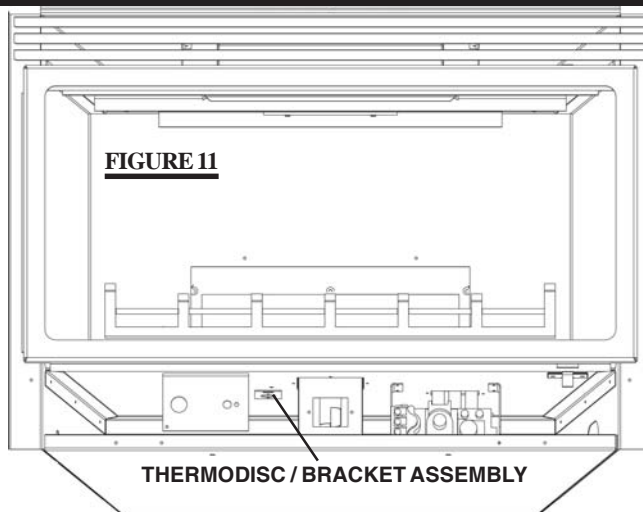

FIGURE 11

damaged.

5. Disconnect the two blower wires. Remove the blower from the mounting plate and replace.
- For thermodisc replacement: Remove the mounting bracket secured to the underside of the burner base. Remove the thermodisc from the bracket and replace.
6. Reconnect the two wires. Re-install the blower gasket. Reattach the blower mounting plate and blower access cover. Replace the logs. Close the fire viewing door.
7. Turn the gas supply and electricity back on.

Because the blower is thermally activated, when turned on, it will automatically start approximately 5-15 minutes after lighting the fireplace insert and will run for approximately 30-45 minutes after the fireplace insert has been turned off. Use of the fan increases the output of heat. Drywall dust will penetrate into the blower bearings causing irreparable damage and must be prevented from coming into contact with the blower or its compartment. Any damage resulting from this condition is not covered by the warranty policy.

ADJUSTMENTS

PILOT BURNER ADJUSTMENT

shutter will cause a more yellow flame, but can lead to carboning. Opening the air shutter will cause a more blue flame, but can cause flame lifting from the burner ports.

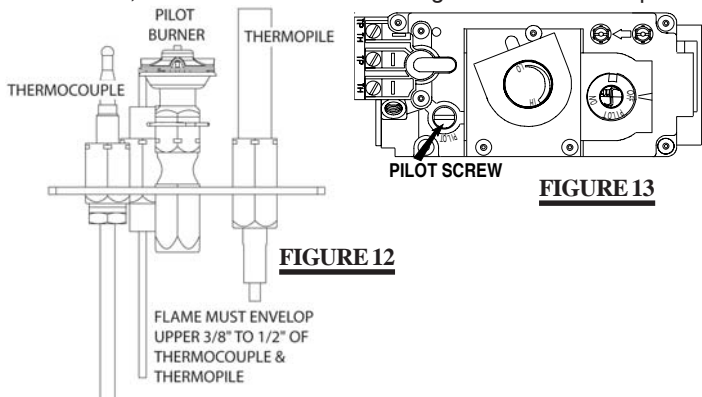

FIGURE 12

FIGURE 13

FLAME MUST ENVELOPE UPPER 3/8" TO 1/2" OF THERMOCOUPLE & THERMOPILE

VENTURI ADJUSTMENT

The flame may not appear yellow immediately; allow 15 to 30 minutes for the final flame colour to be established.

FIGURE 14

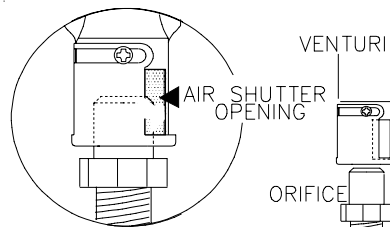

Air shutter adjustment must only be done by a qualified gas installer!

REPLACEMENTS

Contact your dealer for questions concerning prices and availability of replacement parts. Normally all parts can be ordered through your Napoleon dealer or distributor.

FOR WARRANTY REPLACEMENT PARTS, A PHOTOCOPY OF THE ORIGINAL INVOICE WILL BE REQUIRED TO HONOUR THE CLAIM.

When ordering replacement parts always give the following information:

1. MODEL & SERIAL NUMBER OF FIREPLACE
2. INSTALLATION DATE OF FIREPLACE
3. PART NUMBER
4. DESCRIPTION OF PART
5. FINISH

REPLACEMENT PARTS

#	PART #	DESCRIPTION
1	GZ552	REPLACEMENT BLOWER
2	W725-0035	NATURAL GAS VALVE
2	W725-0026	PROPANE GAS VALVE
3	W455-0019	#43 NATURAL GAS BURNER ORIFICE
3	W455-0003	#54 PROPANE GAS BURNER ORIFICE
4	W357-0001	PIEZO IGNITER
5	W680-0004	THERMOPILE
6	W680-0005	THERMOCOUPLE
7	W010-0801	NATURAL GAS PILOT ASSEMBLY
7	W010-0800	PROPANE GAS PILOT ASSEMBLY
8	W690-0002	THERMAL SENSING SWITCH
9	W660-0009	BURNER ON/OFF SWITCH
10	W135-0183	REAR LOG (#1)
11	W135-0184	LEFT MIDDLE LOG (#2)
12	W135-0185	RIGHT MIDDLE LOG (#3)
13	W135-0186	LEFT CROSSOVER LOG (#4)
14	W135-0187	MIDDLE CROSSOVER LOG (#5)
15	W135-0188	RIGHT CROSSOVER LOG (#6)
16	GL-639	LOG SET
17	W361-0016	GLOWING EMBERS
18	W010-1046	BURNER ASSEMBLY
19	W455-0070	NATURAL GAS PILOT INJECTOR
19	W455-0068	PROPANE GAS PILOT INJECTOR
20	W385-0245	NAPOLEON LOGO
21	W562-0008	GLASS GASKET
22	KB-35	VARIABLE SPEED SWITCH
23	W010-1095	GLASS w/ GASKET
24	W010-1042	DOOR, GLASS & GASKET ASSEMBLY

TERMINAL KITS

25	GDI-223	TERMINAL
----	---------	----------

VENT KITS

1-2" & 1-3" DOUBLE PLY ALUMINUM LINER-INLET AND EXHAUST & 2-3" TO 2" REDUCER:

26	GDI-2320KT	VENT KIT 20FT
26	GDI-2325KT	VENT KIT 25FT
26	GDI-2335KT	VENT KIT 35FT

2-3" DOUBLE PLY ALUMINUM LINER-INLET AND EXHAUST:

27	GDI-320KT	VENT KIT 20FT
27	GDI-325KT	VENT KIT 25 FT
27	GDI-335KT	VENT KIT 35 FT

ACCESSORIES:

#	PART NO.	DESCRIPTION
28	GI-1LK	BLACK UPPER & LOWER LOUVRES
28	GI-1LPB	BLACK UPPER & POLISHED BRASS LOWER LOUVRES
28	GI-1LAB	BLACK UPPER & ANTIQUE BRASS LOWER LOUVRES
28	GI-1LSS	BLACK UPPER & BRUSHED STAINLESS STEEL LOWER LOUVRES
28	GI-1LG	GOLD PLATED UPPER & LOWER LOUVRES
29	GI-OIK	BLACK UPPER & LOWER INSET W/ POLISHED BRASS LOWER DOOR TRIM
29	GI-OIG	GOLD PLATED UPPER & LOWER INSET
30	GI30B-KT	BAY FRONT COMPLETE WITH PULL SCREEN
31	GIB-1LK	BLACK LOUVRES
31	GIB-1LPB	POLISHED BRASS LOWER LOUVRES
31	GIB-1LAB	ANTIQU BRASS LOWER LOUVRES
31	GIB-1LSS	BRUSHED STAINLESS STEEL LOWER LOUVRES
31	GIB-1LG	GOLD PLATED LOWER LOUVRES
32	GIB-1OIK	BLACK LOWER INSET
32	GIB-1OIG	GOLD PLATED LOWER INSETS
33	GI-900K6	6" BLACK WITH MARQUIS TRIM
33	GI-900B6	6" POLISHED BRASS WITH MARQUIS TRIM
33	GI-900AB6	6" ANIQUE BRASS WITH MARQUIS TRIM
33	GI-900SS6	6" BRUSHED STAINLESS STEEL BLACK TRIM
34	GI-909S6	6" PORCELAIN ALMOND WITH MARQUIS TRIM
34	GI-909K6	6" PORCELAIN BLACK WITH MARQUIS TRIM
34	GI-909F6	6" PORCELAIN GREEN WITH MARQUIS TRIM
35	GI-900K9	9" BLACK WITH MARQUIS TRIM
35	GI-900B9	9" POLISHED BRASS WITH MARQUIS TRIM
35	GI-900AB9	9" ANTIQUE BRASS WITH MARQUIS TRIM
35	GI-900SS9	9" BRUSHED STAINLESS STEEL WITH BLACK TRIM
36	GI-909S9	9" POCELAIN ALMOND WITH MARQUIS TRIM
36	GI-909K9	9" PORCELAIN BLACK WITH MARQUIS TRIM
36	GI-909F9	9" PORCELAIN GREEN WITH MARQUIS TRIM
37	CISK	CAST SURROUND PAINTED BLACK
37	CISKK	CAST SURROUND PORCELAIN ENAMEL BLACK
37	CISKN	CAST SURROUND PORCELAIN ENAMEL MAJOLICA BROWN
37	CISKB	CAST SURROUND PORCELAIN ENAMEL MAJOLICA BLUE
37	CISKF	CAST SURROUND PORCELAIN ENAMEL MAJOLICA GREEN
38	W690-0001	MILLIVOLT THERMOSTAT
39	W660-0011B	REMOTE CONTROL - ADVANTAGE PLUS
40	GD-660	REMOTE WALL SWITCH WITH 20" WIRE
41	W660-0026	TIMER, BATTERY OPERATED
42	ANI-K	ANDIRONS - BLACK
42	ANI-G	ANDIRONS - GOLD PLATED
43	GI-798KT	DECORATIVE BRICK PANELS
44	GI-910K	6" BEVELLED FLASHING - BLACK
45	GI-942K	TRIM FOR BEVELLED FLASHING - BLACK
45	GI-942B	TRIM FOR BEVELLED FLASHING - POLISHED BRASS
46	GI-RB	RISER BOX - PAINTED BLACK
47*	W175-0218	CONVERSION KIT - LP-NG
47*	W175-0216	CONVERSION KIT - NG-LP

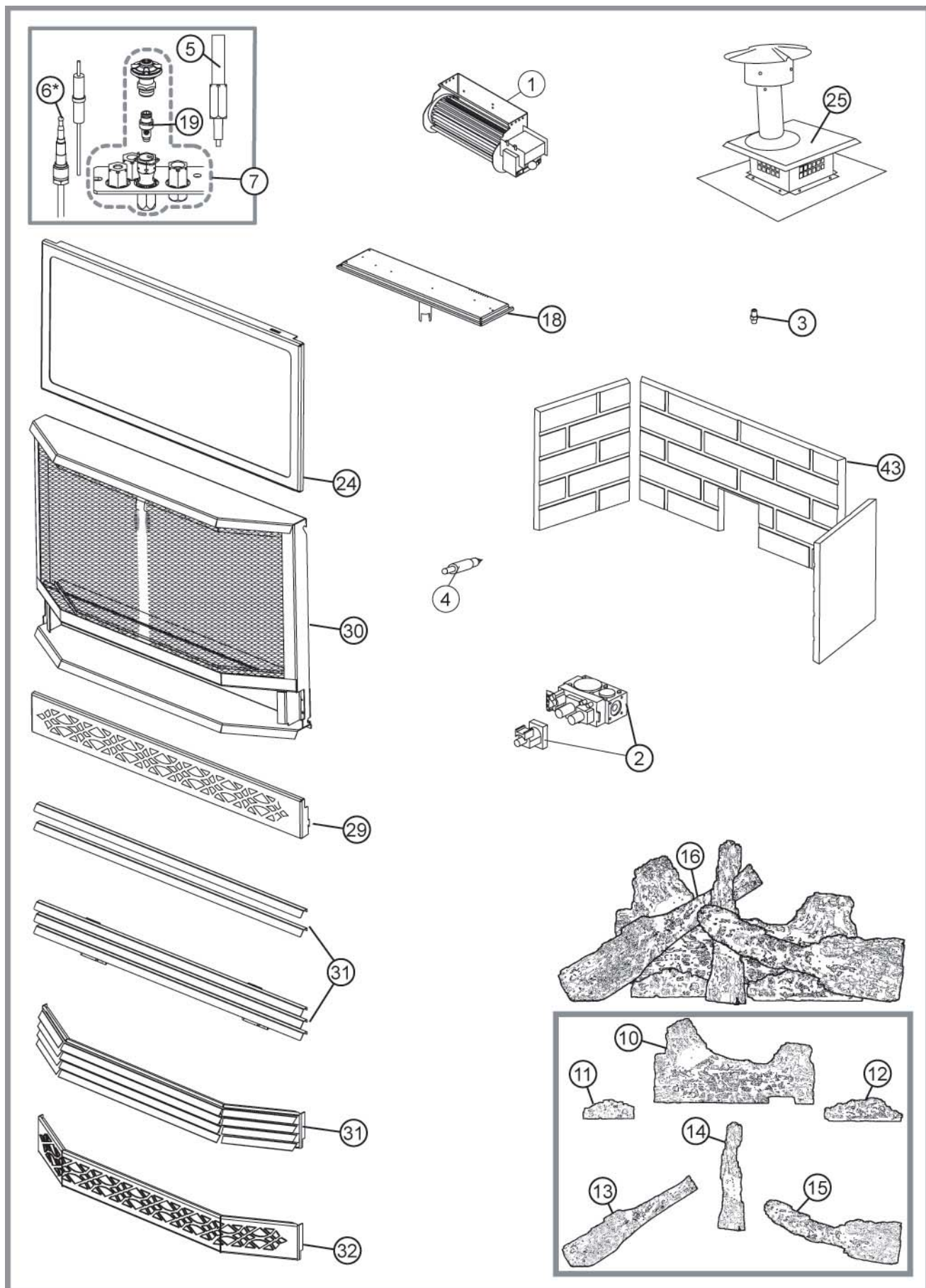

TROUBLE SHOOTING GUIDE

BEFORE ATTEMPTING TO TROUBLESHOOT, PURGE YOUR UNIT AND INITIALLY LIGHT THE PILOT AND THE MAIN BURNER WITH THE GLASS DOOR OPEN.

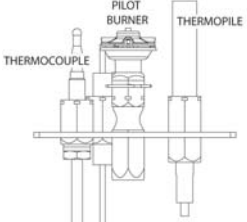
SYMPTOM	PROBLEM	TEST SOLUTION
Pilot will not light. <div style="text-align: center; margin-top: 10px;">  </div>	No spark at pilot burner	<ul style="list-style-type: none"> - check if pilot can be lit by a match - check that the wire is connected to the push button ignitor. - check if the push button ignitor needs tightening. - replace the push button ignitor.
	Spark gap is incorrect	<ul style="list-style-type: none"> - spark gap should be 0.150" to 0.175" (5/32" to 11/64" approx.) from the electrode tip and the pilot burner.
	No gas at the pilot burner	<ul style="list-style-type: none"> - check that the manual valve is turned on. - check the pilot orifice for blockage. - replace the valve. - call the gas distributor.
	Out of propane gas.	<ul style="list-style-type: none"> - fill the tank.
Pilot goes out when the gas knob is released.	System is not correctly purged.	<ul style="list-style-type: none"> - purge the gas line with the glass door open.
	Out of propane gas	<ul style="list-style-type: none"> - fill the tank.
	Pilot flame is not large enough	<ul style="list-style-type: none"> - turn up the pilot flame.
	Pilot flame is not engulfing the thermocouple.	<ul style="list-style-type: none"> - turn up pilot flame. - replace pilot assembly.
	Thermocouple shorting.	<ul style="list-style-type: none"> - loosen and tighten thermocouple. - clean thermocouple and valve connection. - replace thermocouple. - replace valve.
	Faulty thermocouple.	<ul style="list-style-type: none"> - replace.
	Faulty valve.	<ul style="list-style-type: none"> - replace.
Pilot burning; no gas to main burner; gas knob is on 'HI'; wall switch / thermostat is on.	Main burner orifice is plugged.	<ul style="list-style-type: none"> - remove stoppage in orifice.
	Faulty thermopile.	<ul style="list-style-type: none"> - replace.
	Faulty thermostat or switch.	<ul style="list-style-type: none"> - connect a jumper wire across the wall switch terminals; if main burner lights, replace thermostat. - disconnect the switch wires & connect a jumper wire across terminals 1 & 3; if the main burner lights, check the wires for defects and / or replace wires.
	Faulty valve.	<ul style="list-style-type: none"> - replace.
Pilot goes out while standing; Main burner is in 'OFF' position.	Gas piping is undersized.	<ul style="list-style-type: none"> - turn on all gas appliances and see if pilot flame flutters, diminishes or extinguishes, especially when main burner ignites. Monitor supply pressure. - check if supply piping size is to code. Correct all undersized piping.
	Pilot flame is not large enough or not engulfing the thermopile.	<ul style="list-style-type: none"> - turn up pilot flame. - replace pilot assembly.
Main burner goes out; pilot stays on.	Thermopile shorting	<ul style="list-style-type: none"> - clean thermopile and thermopile connection to valve.
	Remote wall switch wire is too long, too much resistance in the system	<ul style="list-style-type: none"> - shorten wire to correct length or wire gauge.
	Faulty thermostat or switch	<ul style="list-style-type: none"> - replace

SYMPTOM	PROBLEM	TEST SOLUTION
Main burner goes out; pilot goes out.	REFER TO "MAIN BURNER GOES OUT; PILOT STAYS ON"	
	Vent re-circulating	- check joint seals and installation.
	Thermocouple shorting or faulty.	- loosen and tighten thermocouple - clean thermocouple and valve connection. - replace thermocouple. - replace valve.
	Vent is reversing	- check all venting and insert seals. - check that door is properly sealed. If the insert is allowed to burn with the door open when purging the unit, exhaust products may reverse the venting action. Let the unit cool down to correct the reversed venting action.
Exhaust fumes smelled in room, headaches.	Fireplace is spilling.	- check all seals.
Carbon is being deposited on glass, logs or combustion chamber surfaces.	Air shutter has become blocked	- ensure air shutter opening is free of lint or other obstructions.
	Flame is impinging on the logs or combustion chamber.	- check that the logs are correctly positioned. - open air shutter to increase the primary air. - check the input rate: check the manifold pressure and orifice size as specified by the rating plate values. - check that the door gasketing is not broken or missing and that the seal is tight. - check that both vent liners are free of holes and well sealed at all joints.
Main burner flame is a blue, lazy, transparent flame.	Blockage in vent.	- remove blockage. In really cold conditions, ice buildup may occur on the terminal and should be removed as required.
	Incorrect installation.	- vent liners are reversed. Refer to Figures 2 & 3. - check all venting and insert seals.
White / grey film forms.	Sulphur from fuel is being deposited on glass, logs or combustion chamber surfaces.	- clean the glass with a recommended gas fireplace glass cleaner. DO NOT CLEAN GLASS WHEN HOT. If deposits are not cleaned off regularly, the glass may become permanently marked.
Flames are very aggressive.	Door is ajar	-ensure door seal is tight.

